



2018 CONSTRUCTION ROADSHOW

# PCBUs Primary Duty of Care

Includes providing and maintaining as far as reasonably practical:

- a work environment without risks to health and safety.
- safe plant and structures.
- safe systems of work.

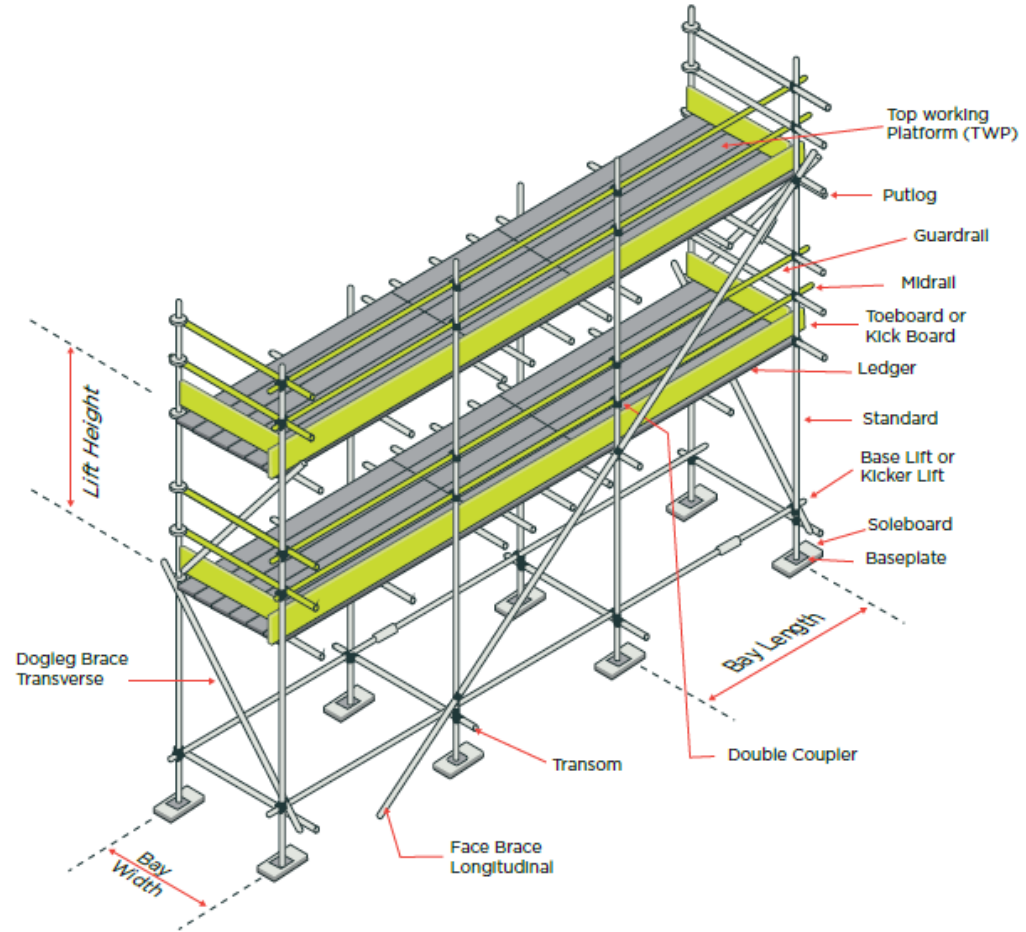

Top working Platform (TWP)

Putlog

Guardrail

Midrail

Toeboard or Kick Board

Ledger

Standard

Base Lift or Kicker Lift

Soleboard

Baseplate

Lift Height

Bay Length

Bay Width

Dogleg Brace Transverse

Transom

Face Brace Longitudinal

Double Coupler

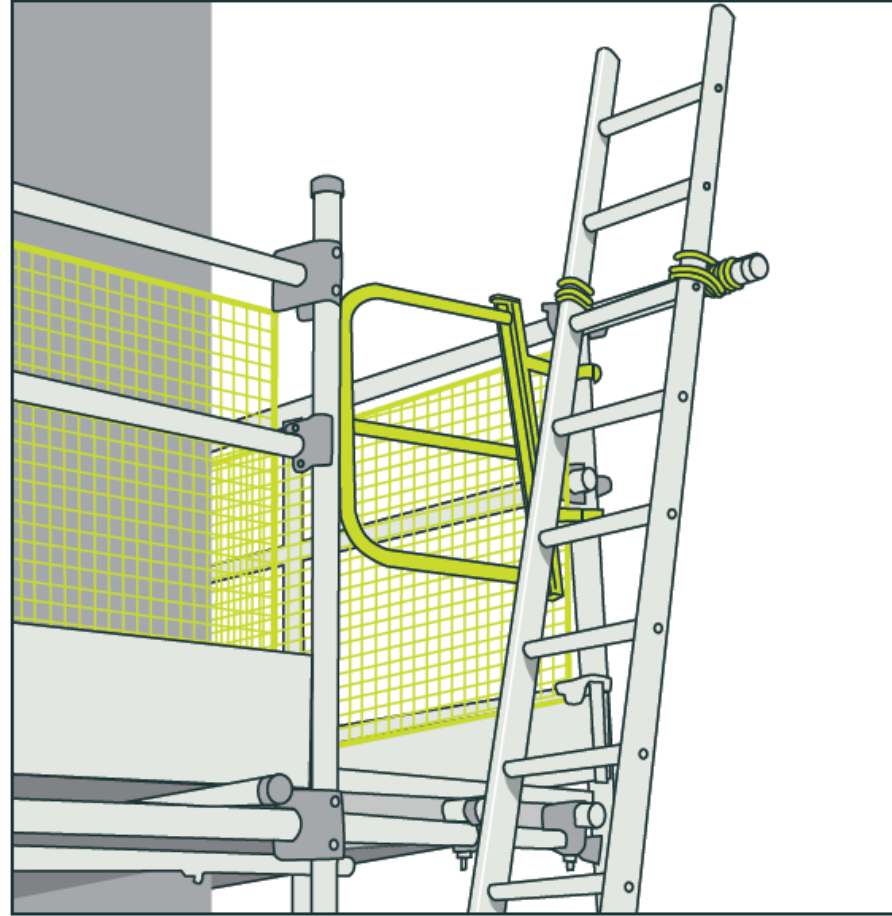

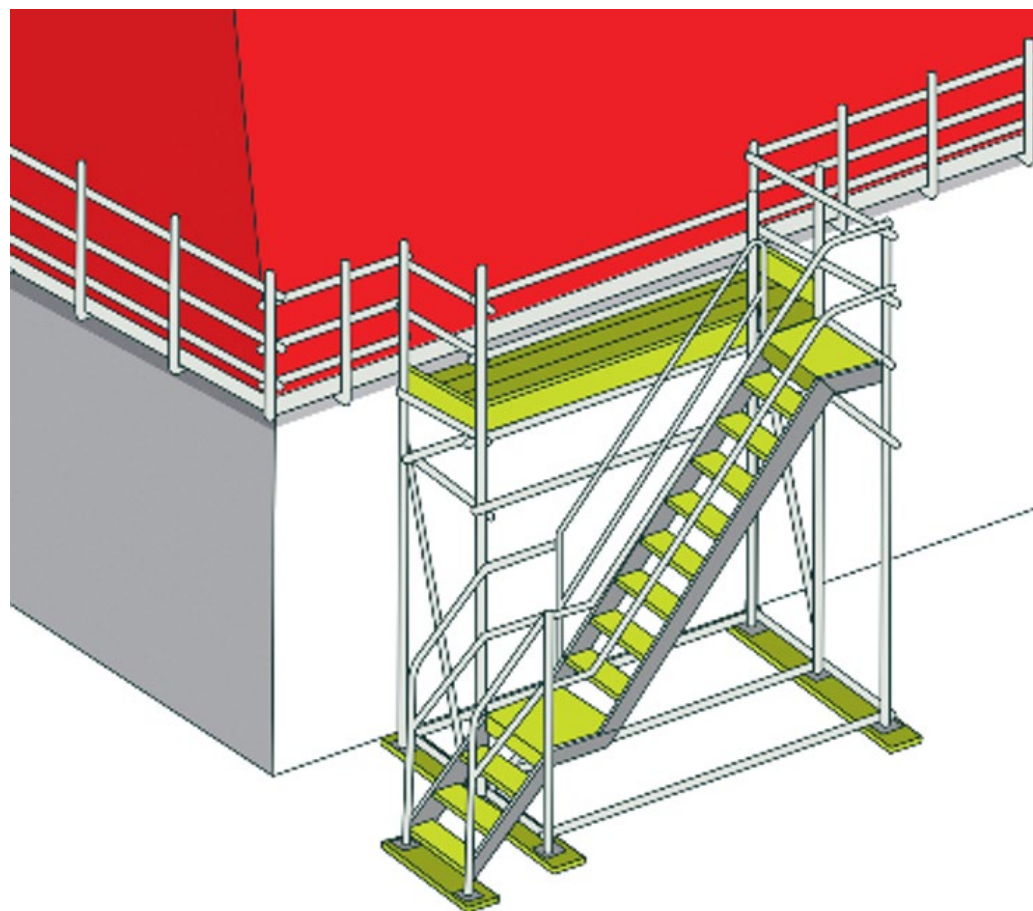

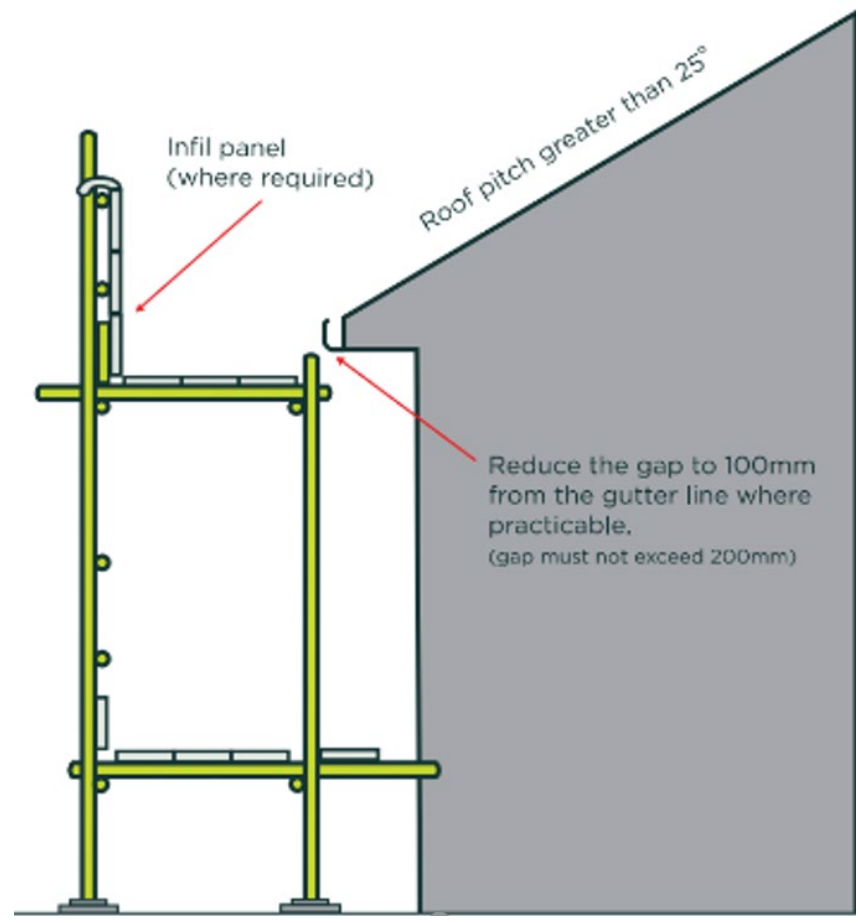

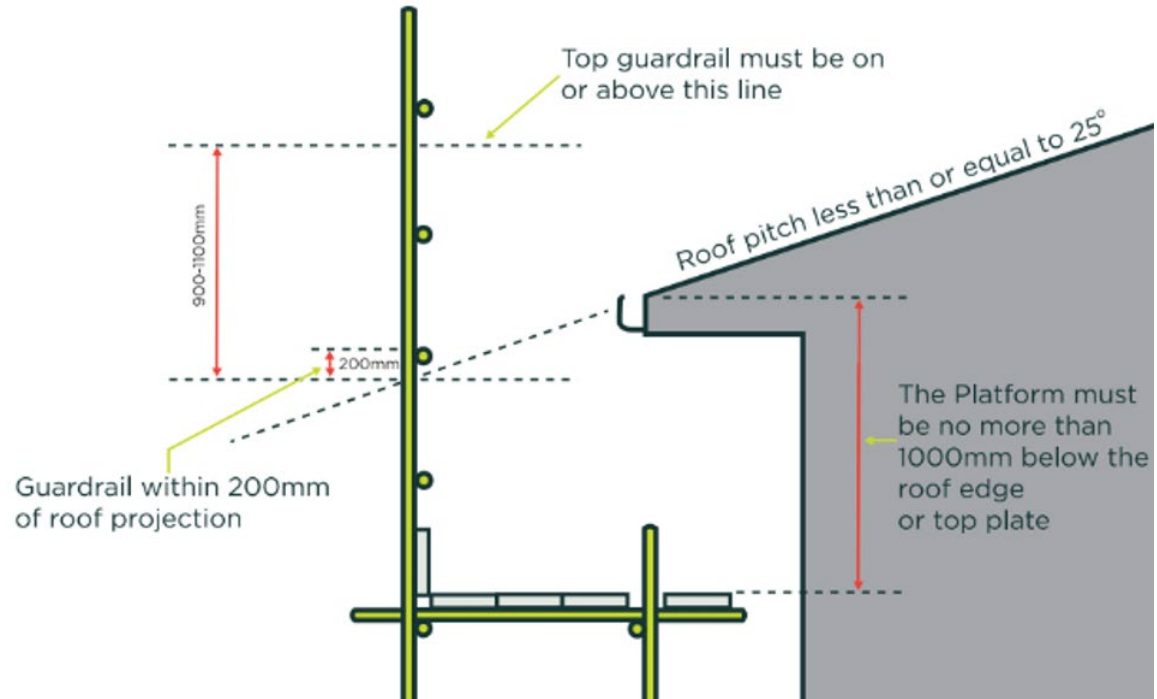

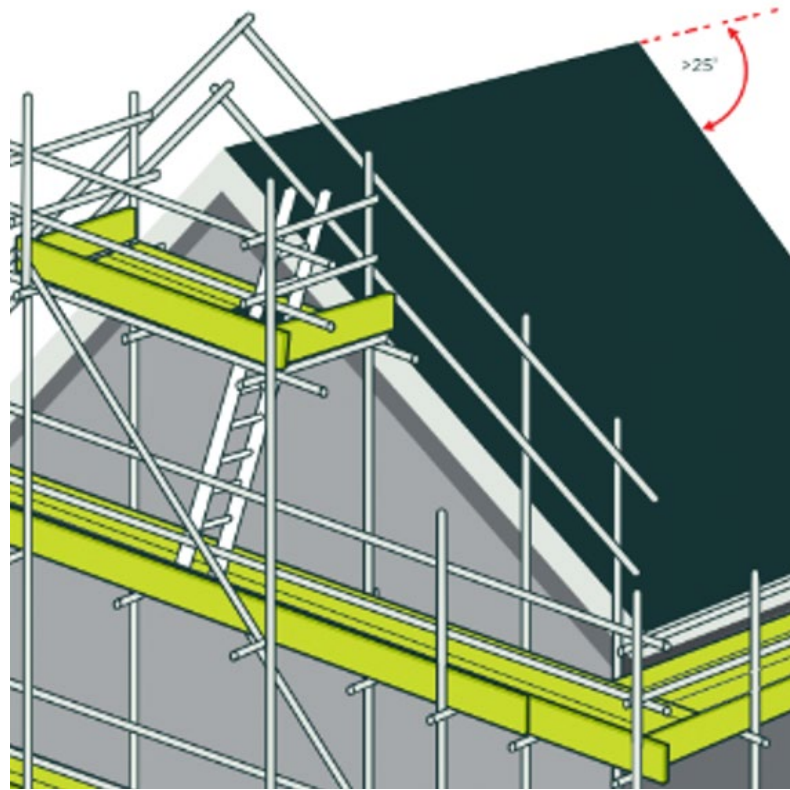





Scaffolds under  
5m high

---

Measured to the highest  
component

---

Must be erected, altered  
and dismantled by a  
competent person

---

Must comply with the GPG  
and manufacturers  
information

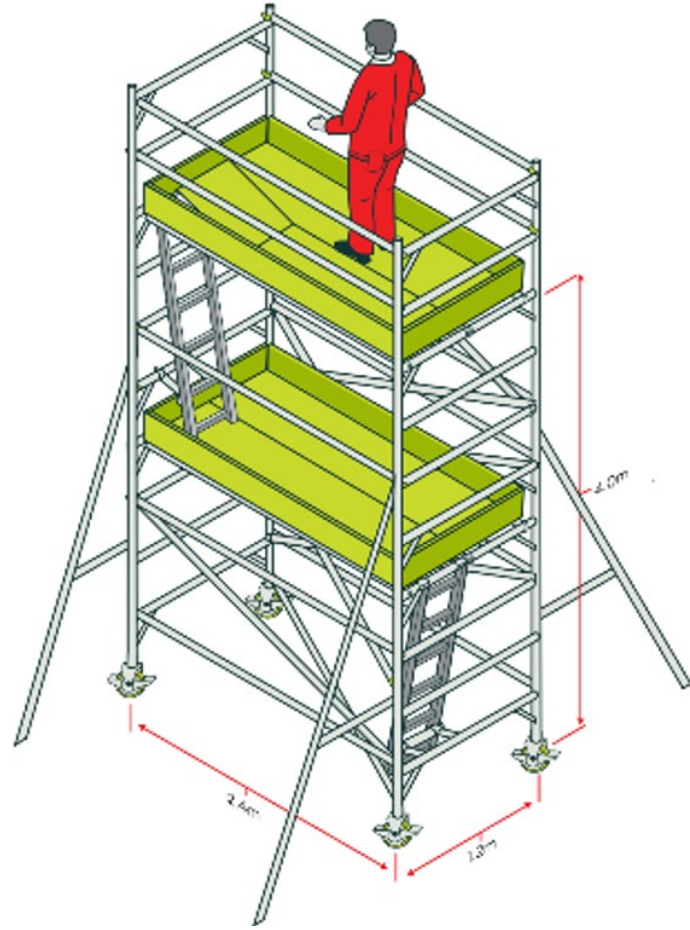



## COMPETENT PERSON

has the knowledge and skills to carry out a particular task acquired through:

- training,
- or qualification,
- or experience,
- or a combination of these.

## CONSTRUCTSAFE TIER 2 SCAFFOLDING



## NZQA UNIT STANDARDS

- 9184 Erect and dismantle prefabricated frame scaffolds up to 5m in height
- 13016 Demonstrate knowledge of erection and dismantling of scaffolding up to 5m in height
- 13053 Erect and dismantle scaffolding up to 5m in height

# Certificates of Competence

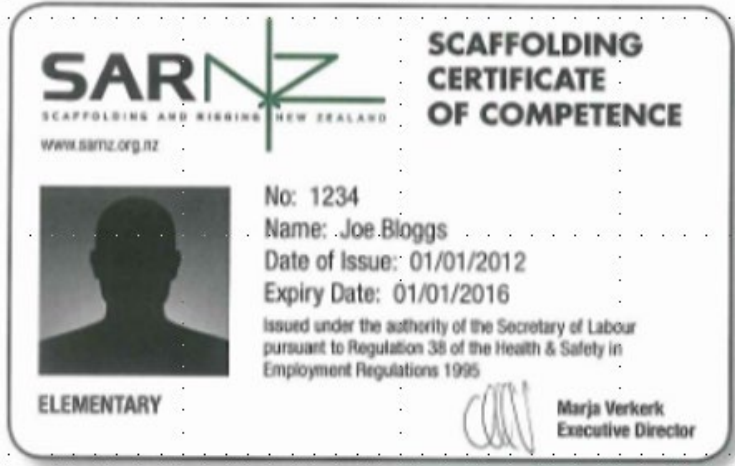

**ELEMENTARY**



**SUSPENDED**



**INTERMEDIATE**

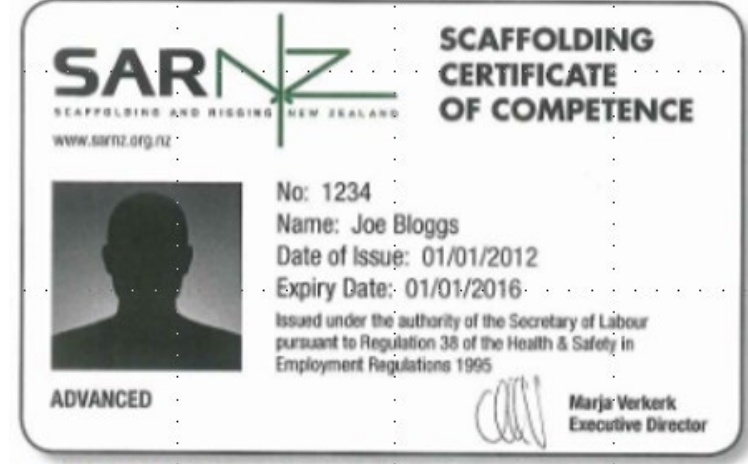

**ADVANCED**

Scaffold type	Inspection frequency	Inspection done by
<p><b>All scaffolds, regardless of height, that are in use for a week or more</b></p>	<ul style="list-style-type: none"> <li>• Weekly while in use.</li> <li>• Monthly while set up but not in use.</li> <li>• After each alteration, repair or addition.</li> <li>• After any storm or event that could adversely affect the safety of the scaffold.</li> </ul>	<p>Certified scaffolder or competent person, depending on the type of scaffolding.</p>
<p><b>Notifiable scaffolds</b></p>	<p>As above.</p>	<p>Certified scaffolder.</p>
<p><b>Suspended scaffolds</b></p>	<p>As above and before first use.</p>	<p>Certified scaffolder.</p>
	<p>Daily as part of the pre-start check.</p>	<p>The user.</p>

Scaffold type	Inspection frequency	Inspection done by
<p>All scaffolds, regardless of height, that are in use for a week or more</p>	<ul style="list-style-type: none"> <li>• Weekly</li> <li>• If not in use</li> </ul>	<p>Certified scaffolder or competent person, depending on the type of scaffolding.</p>
<p>Notifiable scaffolds (See section 2.5)</p>		<p>Certified scaffolder.</p>
<p>Suspended scaffolds (See section 12)</p>		<p>Certified scaffolder.</p>
	<p>check.</p>	<p>The user.</p>



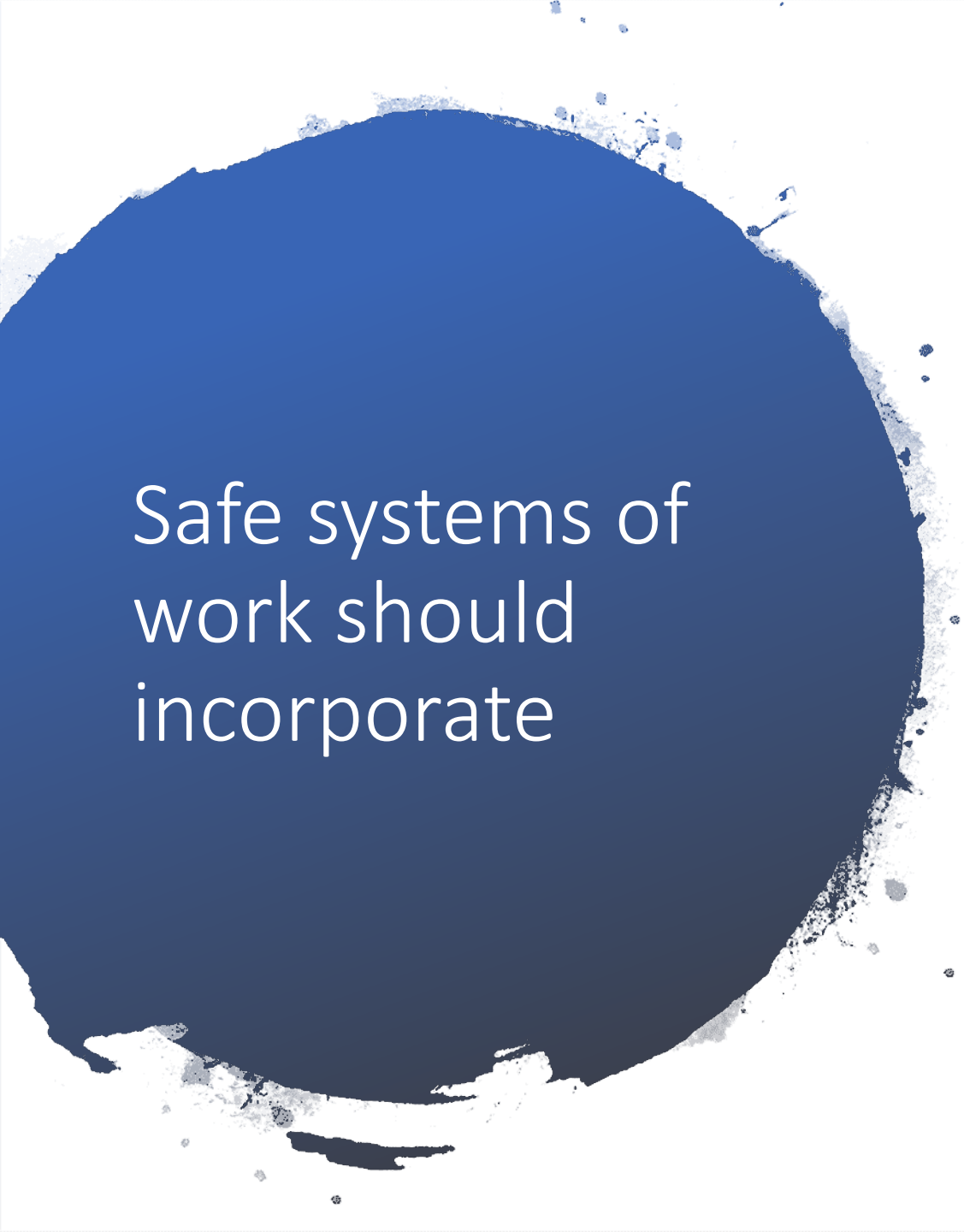

Safe systems of  
work should  
incorporate

---

Planning

---

Risk assessment

---

Managing risks

---

Monitoring Risks



# Safe Erection and Dismantle

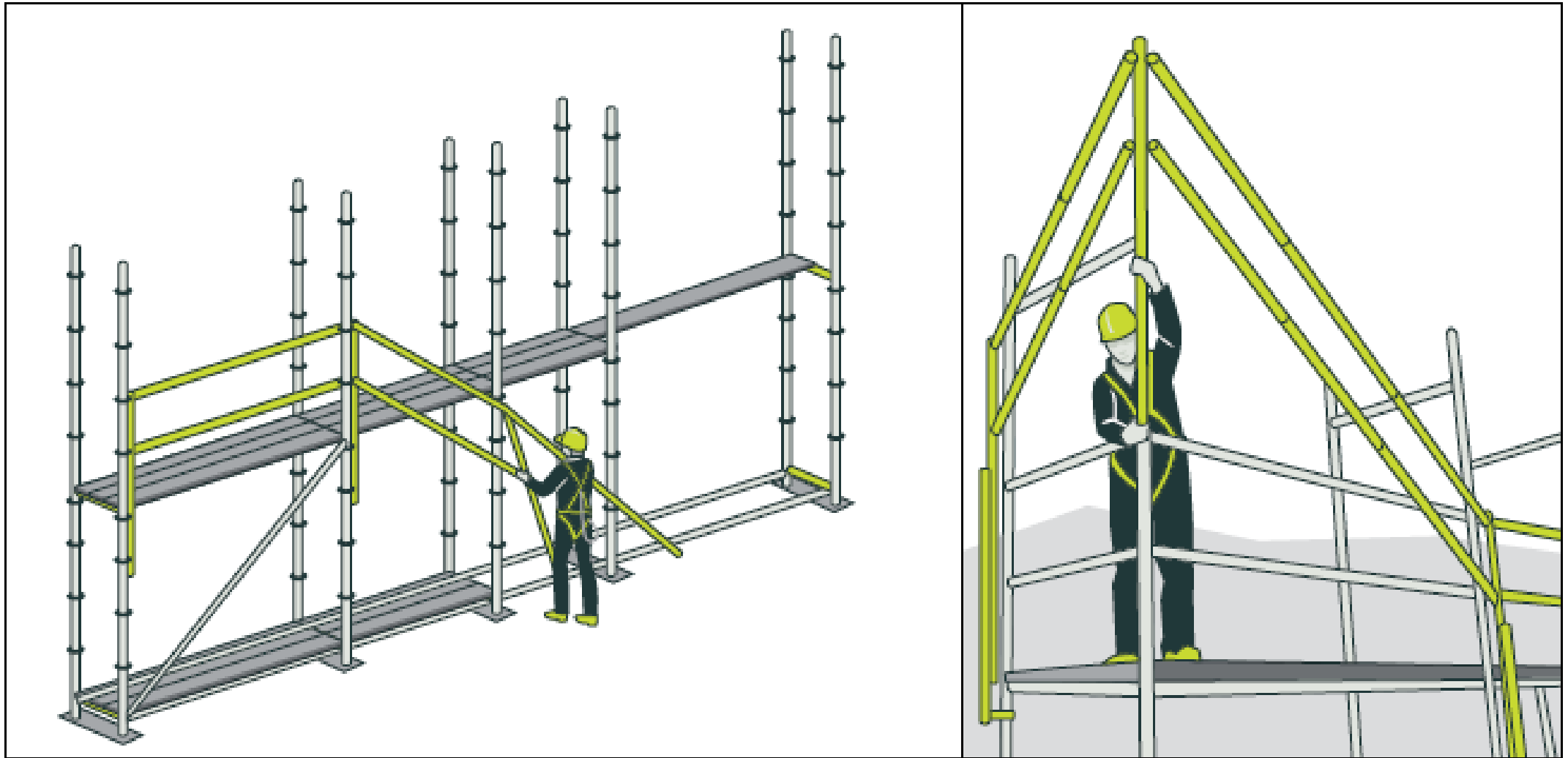

# Safe Erection and Dismantle





# PCBUs with Overlapping Duties

---

Happens on a shared workplace  
(Construction site)

---

Happens in a contracting chain  
(Developer, Main Contractor, Sub  
Contractor)

---

Overlapping duties can occur  
between parties with no contractual  
relationship (Scaffold company and  
other subcontractor on same site)



# Worker engagement & safe systems of work

PCBUs must engage with workers on health and safety matters that might affect them.

Workers include employees, contractors, subcontractors and others.











Planning and  
Engagement

**Compliance**



**Planning** AND  
**Engagement**



**Safety** AND **Efficiency**

Planning and  
Engagement

**Safety AND Efficiency**



**Cost Savings**



**\$ PROFIT \$**



**GUIDELINES 2018**

**ACCESS AND  
FALL PROTECTION  
IN RESIDENTIAL  
CONSTRUCTION**

- SCAFFOLDING
- EDGE PROTECTION
- SAFETY NETS
- SOFT LANDING BAGS



**GUIDELINES 2018**

**ACCESS AND  
FALL PROTECTION  
IN RESIDENTIAL  
CONSTRUCTION**

- REQUIREMENTS FOR DIFFERENT SYSTEMS & USES
- COMPETENCE
- WHERE TO FIND MORE INFO
- SELECTING THE MOST EFFICIENT SYSTEM FOR THE JOB

GOOD PRACTICE  
GUIDELINES

# Scaffolding in New Zealand



NOVEMBER 2016



New Zealand Government

**WORKSAFE**  
NEW ZEALAND | 111 702 222

THE MUST HAVE GUIDE FOR  
SAFE ERECTION AND USE OF  
ALL TYPES OF SCAFFOLD

# SPECIAL DEAL

Residential Guidelines  
AND  
Good Practice Guidelines  
for Scaffolding  
**\$35 including delivery!!**

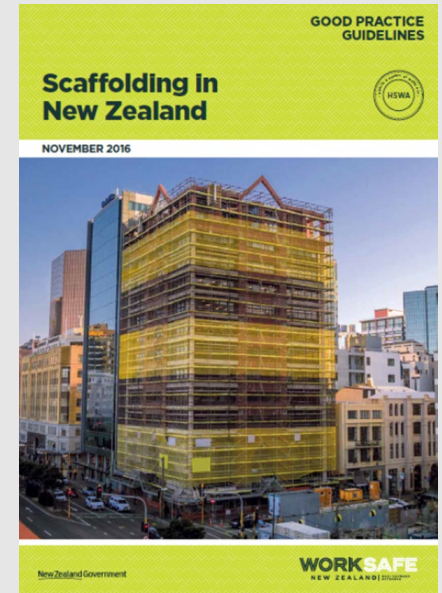
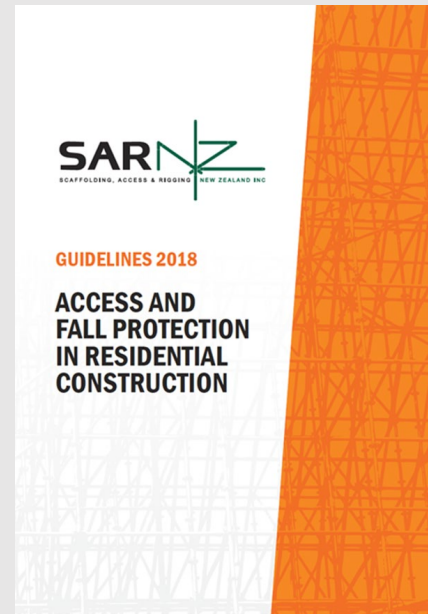

Why use a  
SARNZ  
member?

**Highest professional  
standards**

**Full insurance, trained staff,  
drug testing**

**Must meet standards set in  
Good Practice Guidelines**

**Support from SARNZ if  
something goes wrong**